

Rocktech Displays Limited



Module P/N: RK101HU01H-CTG

Version: 1.0

Description : 10.1 inch TFT 1024*600 Pixels with LED backlight, All viewing angle, Capacitive touch panel, 800 nits brightness

TEL: 0086-755-26065260

Fax: 0086-755-26065261

E-mail: Sales@rocktech.com.hk

Web: www.rocktech.com.hk

Revision History

Date	Rev.	Page	Description
2020-11-19	1.0	All	Modify CTP Driver IC

CONTENTS

- GENERAL FEATURES
- ABSOLUTE MAXIMUM RATINGS
- ELECTRICAL SPECIFICATIONS
- OPTICAL SPECIFICATIONS
- BLOCK DIAGRAM
- PIN DESCRIPTION
- TIMING CHARACTERISTICS
- OUTLINE DIMENSION
- RELIABILITY AND INSPECTION STANDARD
- PRECAUTIONS

1. General Features

Item	Spec	Remark
Display Mode	Normally Black transmissive	
Viewing Direction	Free	
Input Signals	LVDS	
Outside Dimensions	235(W) x143.0(H) x4.8(D)	With CTP
Active Area	222.72mm(W)×125.28mm(H)	
Number of Pixels	1024(RGB)×600	
Dot Pitch	0.2175(H) ×0.2088mm(W)	
CTP Driver IC	GT928	

2. Absolute Maximum Ratings

The following are maximum values which, if exceeded may cause operation or damage to the unit.

ITEM	Sym.	Min.	Max.	Unit	Remark
Power Supply Voltage	Vcc	-0.3	5.0	V	GND=0
Logic Signal Input Level	Vinput	-0.3	Vcc+0.3	V	
Operation Temperature	Top	-20	70	°C	
Storage Temperature	Tst	-30	80	°C	

3. Electrical Specification

3.1 Driving TFT LCD Panel

ITEM	Sym.	Min.	Typ.	Max.	Unit	Remark
Supply Voltage	Vcc	3.0	3.3	3.6	V	
	VGH	19.4	20.0	20.6	V	
	VGL	-10.3	-10.0	-9.7	V	
	Avdd	8.7	9.0	9.3	V	
	Vcom	4.11	4.41	4.71	V	
Input Signal Voltage	VIH	0.7Vcc	-	Vcc	V	
	VIL	0	-	0.3Vcc	V	

3.2 Driving Backlight

Item	Sym.	Min	Typ.	Max	Unit	Note
Backlight driving voltage	V _F	16.8	18.0	19.2	V	
Backlight driving current	I _F	225	300	375	mA	
Backlight Power Consumption	W _{BL}	-	5400	-	mW	
Life Time	-	-	30,000	-		Note 3

Note 1: (Unless specified, the ambient temperature Ta=25°C)

Note 2: The recommended operating conditions refer to a range in which operation of this product is guaranteed. Should this range is exceeded, the operation cannot be guaranteed even if the values may be without the absolute maximum ratings.

Note 3: If LED is driven by high current, high ambient temperature & humidity condition. The life time of LED will be reduced. Operating life means brightness goes down to 50% initial brightness. Typical operating life time is estimated data.

4. Optical Specifications

Optical characteristics are determined after the unit has been 'ON' and stable for approximately 30 minutes in a dark environment at 25 °C. The values specified are at an approximate distance 500mm from the LCD surface at a viewing angle of Φ and θ equal to 0°.

Item	Sym.	Values			Unit	Note
		Min.	Typ.	Max.		
1) Contrast Ratio	C/R	600	800	-		FIG.1
2) Module Luminance	L	650	800	-	cd/m ²	After CTP
3) Response time	Tr+Tf	-	30	-	Ms	FIG.2
4) Viewing Angle	θ_T	-	85	-	Degree	FIG.3
	θ_B	-	85	-		
	θ_L	-	85	-		
	θ_R	-	85	-		
5) Chromaticity	Wx	0.259	0.309	0.359		
	Wy	0.297	0.347	0.397		
	Rx	-	-	-		
	Ry	-	-	-		
	Gx	-	-	-		
	Gy	-	-	-		
	Bx	-	-	-		
	By	-	-	-		

◆ Measurement System

Notes:

1. Contrast Ratio(CR) is defined mathematically as :

$$\text{Contrast Ratio} = \frac{\text{Surface Luminance with all white pixels}}{\text{Surface Luminance with all black pixels}}$$
2. Surface luminance is the center point across the LCD surface 500mm from the surface with all pixels displaying white. For more information see FIG 1.
3. Response time is the time required for the display to transition from white to black (Rising Time, Tr) and from black to white (Falling Time, Tf). For additional information see FIG 2.
4. Viewing angle is the angle at which the contrast ratio is greater than 10. The angles are determined for the horizontal or x axis and the vertical or y axis with respect to the z axis which is normal to the LCD surface. For more information see FIG 3.

FIG. 1 Optical Characteristic Measurement Equipment and Method

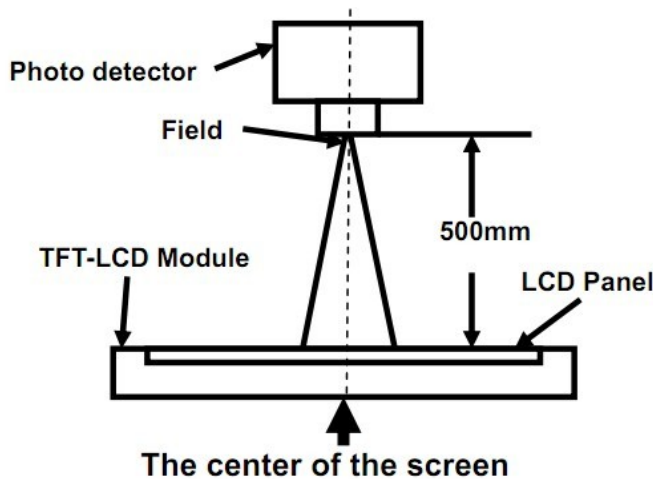

Item	Photo detector	Field
Contrast Ratio	SR-3A	1°
Luminance		
Chromaticity		
Lum Uniformity		
Response Time	BM-7A	2°

FIG. 2 The definition of Response Time

The response time is defined as the following figure and shall be measured by switching the input signal for “black” and “white”.

$$\text{Response Time} = \text{Rising Time}(Tr) + \text{Falling Time}(Tf)$$

- Rising Time(T_r) : Full White 90% → Full White 10% Transmittance.
- Falling Time(T_f) : Full White 10% → Full White 90% Transmittance.

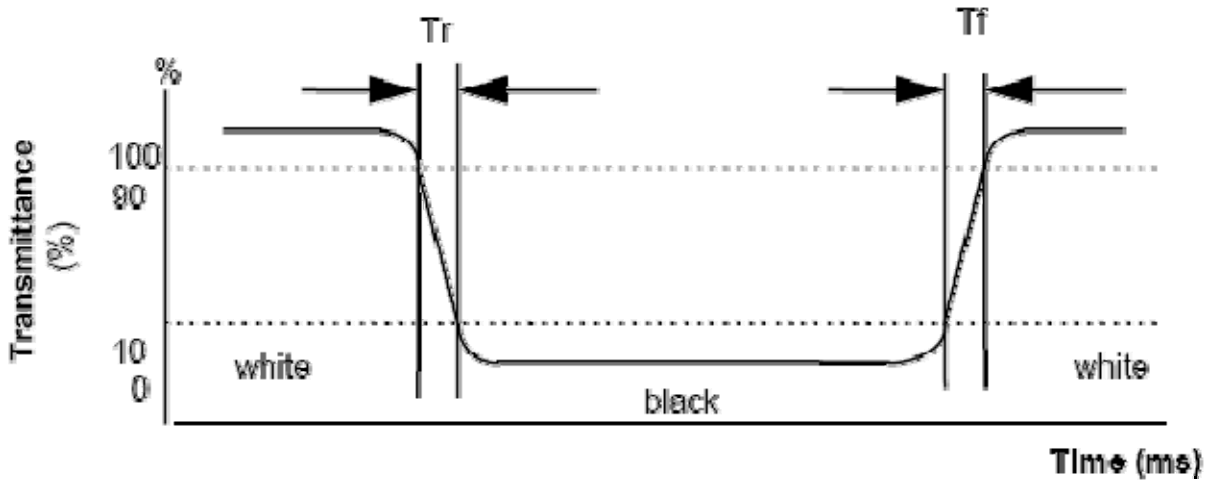
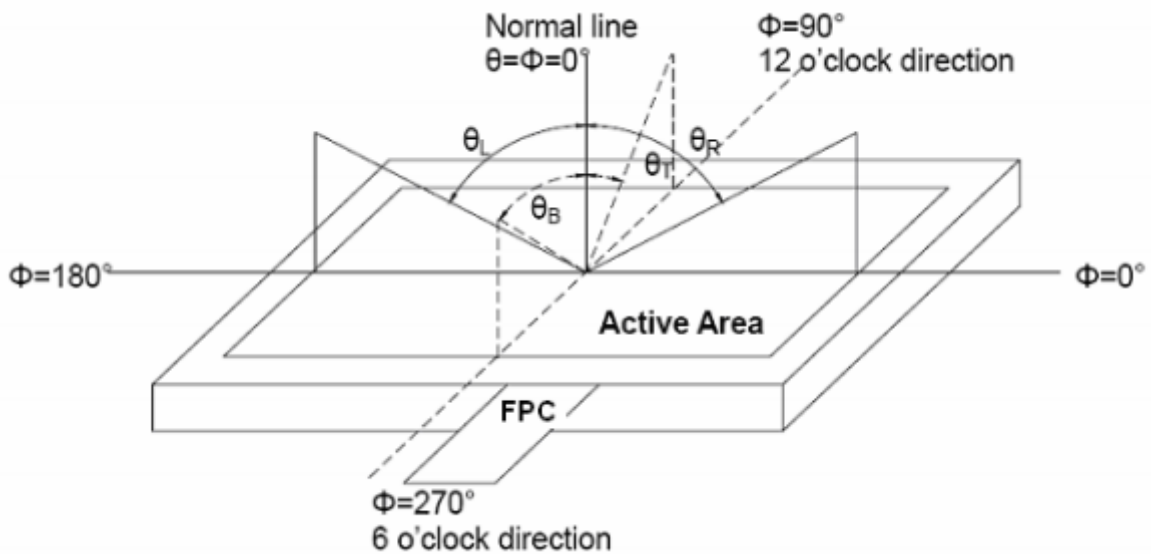
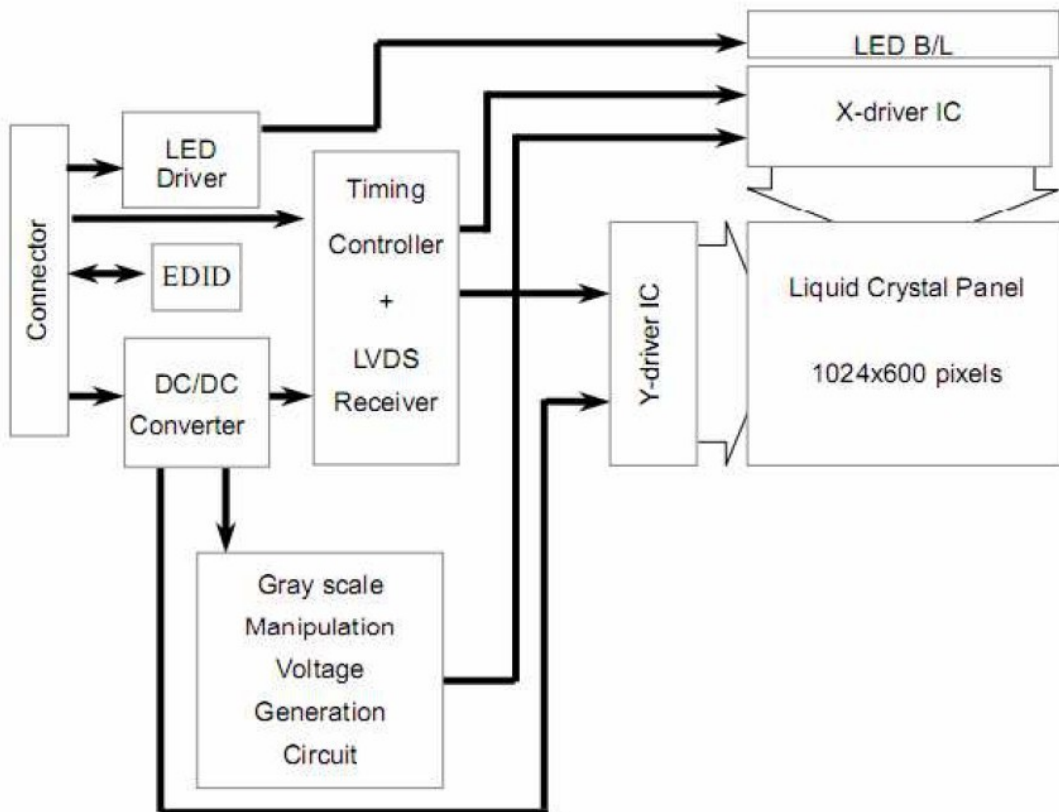

FIG. 3 The definition of Viewing Angle

Use Fig. 1(Test Procedure) under Measurement System to measure the contrast from the measuring direction specified by the conditions as the following figure.



5. Block Diagram



6. Pin Description

6.1 TFT PIN Interface

PIN NO	SYMBOL	Description
1	VCOM	Comon Voltage
2	VDD	Power Voltage for digital circuit
3	VDD	Power Voltage for digital circuit
4	NC	No connection
5	RESET	Global reset pin.Active low to enter reset state.Suggest to connecting with an RC reset circuit for stability. Normal pull high. (R=10K ohm, C=0.1uF) Note:If RC is not added,users must follow the rule, T2>50ms to keep low power.
6	STBYB	Standby mode,Normal pulled high STBYB=1,normal operation; STBYB=0,timing controller,source driver will turn off,all output are High-Z.
7	GND	Ground
8	RXIN0-	-LVDS differential data input
9	RXIN0+	+LVDS differential data input
10	GND	Ground
11	RXIN1-	-LVDS differential data input
12	RXIN1+	+LVDS differential data input
13	GND	Ground
14	RXIN2-	-LVDS differential data input
15	RXIN2+	+LVDS differential data input
16	GND	Ground
17	RXCLKI N-	-LVDS differential clock input
18	RXCLKI N+	+LVDS differential clock input
19	GND	Ground
20	RXIN3-	-LVDS differential data input
21	RXIN3+	+LVDS differential data input
22	GND	Ground
23	NC	No connection

24	NC	No connection
25	GND	Ground
26	NC	No connection
27	NC	No connection
28	SELB	6bit/8bit mode select (Note 1)
29	AVDD	Power for Analog Circuit
30	GND	Ground
31	LED-	LED Cathode
32	LED-	LED Cathode
33	L/R	Horizontal inversion (Note 2)
34	U/D	Vertical inversion (Note 2)
35	VGL	Gate OFF Voltage
36	NC	No connection
37	NC	No connection
38	VGH	Gate ON Voltage
39	LED+	LED Anode
40	LED+	LED Anode

I:input O:Output P:Power

Note1: If LVDS input data is 6 bits, SELB must set to High;
 If LVDS input data is 8 bits, SELB must set to Low.

Note2: When L/R=0, set right to left scan direction.
 When L/R=1, set left to right scan direction.
 When U/D=0, set top to bottom scan direction.
 When U/D=1, set bottom to top scan direction.

6.2 CTP PIN Interface

Pin	Symbol	Description
1	SDA	I2C data
2	SCL	I2C clock
3	Reset	Reset
4	INT	Interrupt
5	VDD	Working voltage 2.8V~3.3V
6	GND	GND

CTP IC driver source code will be offered separately.

7. Timing Characteristics

7.1 LVDS mode DC electrical characteristics

Parameter	Symbol	Condition	Spec.			Unit
			Min.	Typ.	Max.	
Differential input high Threshold voltage	R_{XVTH}	$R_{XVCM}=1.2V$	-	-	+0.1	V
Differential input low threshold voltage	R_{XVTL}		-0.1	-	-	V
Input voltage range (Singed-end)	R_{XVIN}	-	0	-	$VDD-1.2+ V_{ID} /2$	V
Differential input common mode voltage	R_{XVCM}	-	$ V_{ID} /2$	-	$VDD-1.2$	V
Differential input voltage	$ V_{ID} $	-	0.2	-	0.6	V
Differential input leakage Current	$R_{V_{XIZ}}$	-	-10	-	+10	μA
LVDS digital operating Current	I_{ddlvds}	Fclk=65MHz, VDD=3.3V	-	15	30	mA
LVDS digital stand-by Current	I_{stlvds}	Clock & all functions are stopped	-	10	50	μA

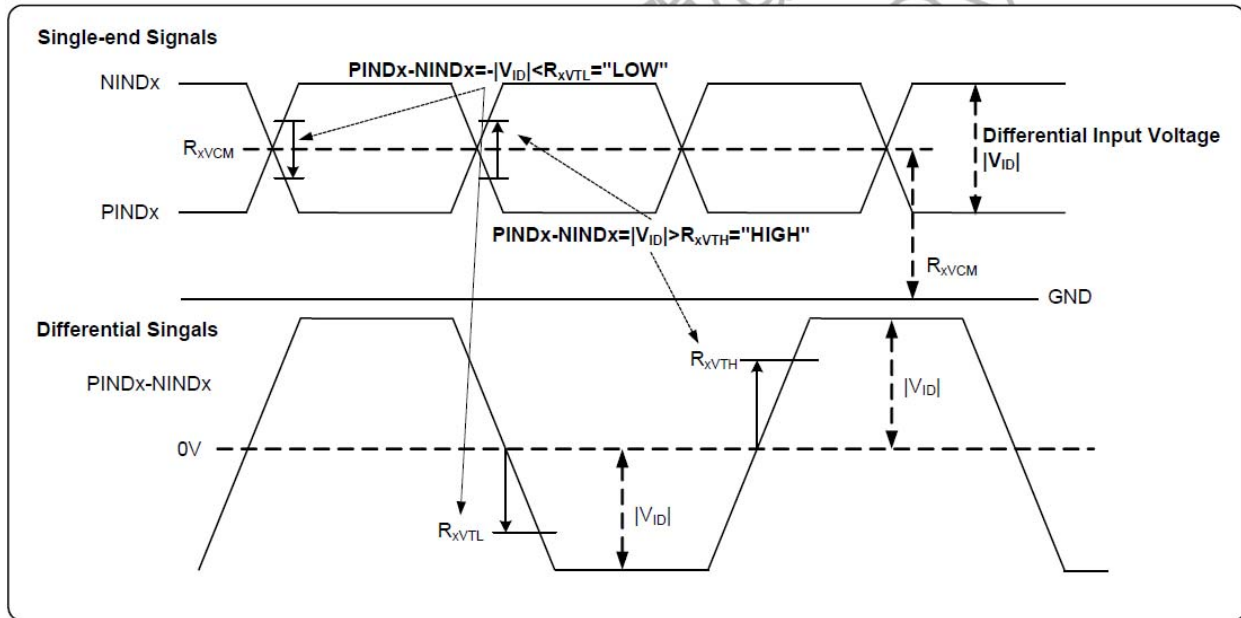

7.2 LVDS mode data input format

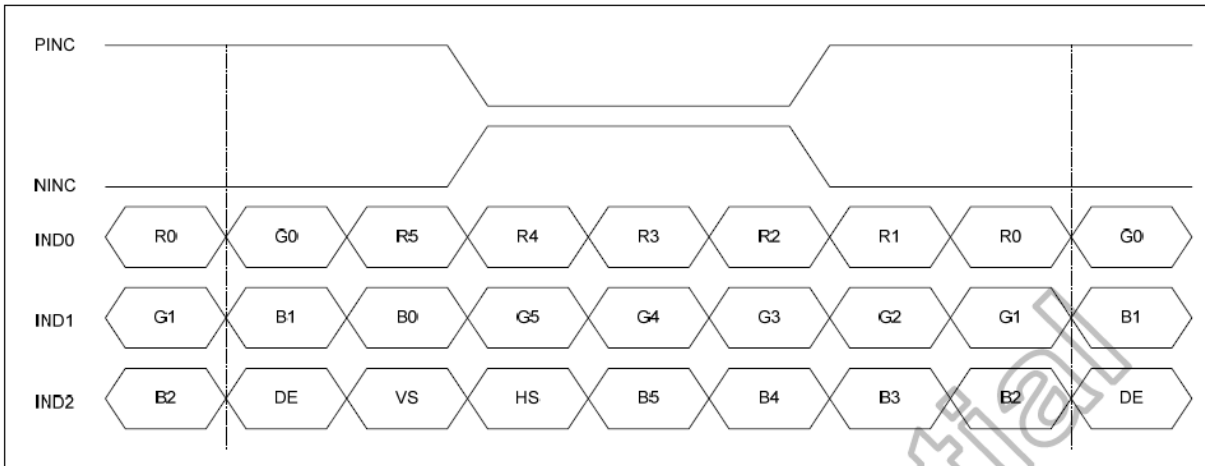

Figure 10.4: 6-bit LVDS input

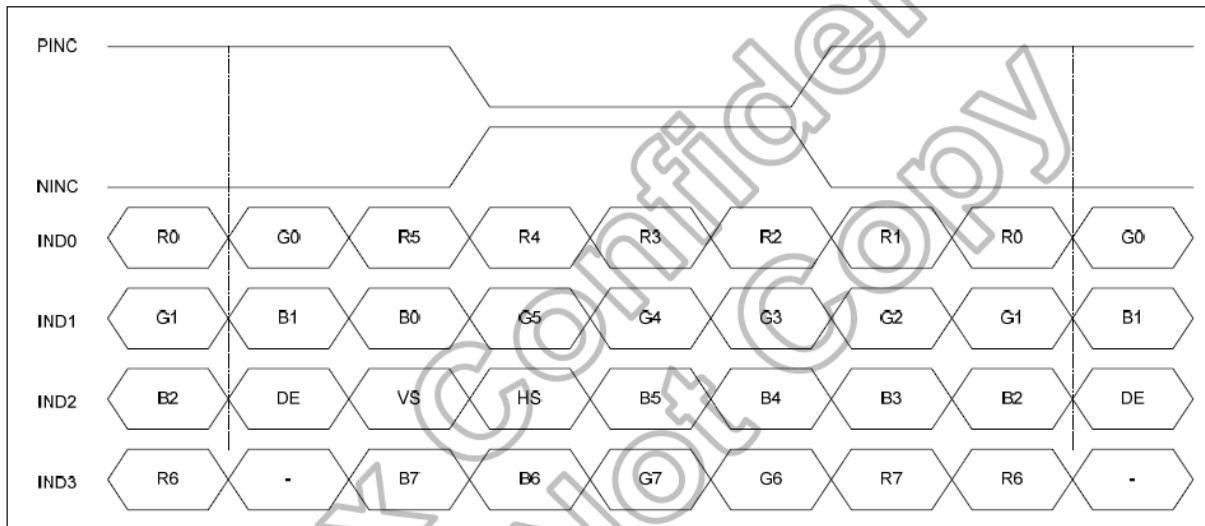

Figure 10.5: 8-bit LVDS Input

7.3 Input timing table

DE mode

Parameter	Symbol	Spec.			Unit
		Min.	Typ.	Max.	
DCLK frequency	fclk	40.8	51.2	67.2	MHz
Horizontal display area	thd		1024		DCLK
HSD period	th	1114	1344	1400	DCLK
HSD blanking	thb+ thfp	90	320	376	DCLK
Vertical display area	tvd		600		T _H
VSD period	tvbp	610	635	800	T _H
VSD blanking	tvbp+ tvfp	10	35	200	T _H

HV mode

• Horizontal timing

Parameter	Symbol	Spec.			Unit
		Min.	Typ.	Max.	
DCLK frequency	fclk	44.9	51.2	63	MHz
Horizontal display area	thd		1024		DCLK
HSD period	th	1200	1344	1400	DCLK
HSD pulse Width	thpw	1	-	140	DCLK
HSD back porch	thbp		160		DCLK
HSD front porch	thfp	16	160	216	DCLK

Table 10.6: HV mode horizontal timing (1024x600)

• Vertical timing

Parameter	Symbol	Spec.			Unit
		Min.	Typ.	Max.	
Vertical display area	tvd		600		T _H
VSD period	tv	624	635	750	T _H
VSD pulse width	tvpw	1	-	20	T _H
VSD back porch	tvbp		23		T _H
VSD front porch	tvfp	1	12	127	T _H

Table 10.7: HV Mode Vertical Timing (1024x600)

7.4 Power on/off Sequence

To prevent the device damage from latch up, the power on/off sequence shown below must be followed.

Power on: VDD, GND → AVDD, AGND → V1 to V14

Power off: V1 to V14 → AVDD, AGND → VDD, GND

HX8282-A01 has a power on/off sequence control function. In order to prevent IC from power on reset fail, the rising time (T_{POR}) of the digital power supply VDD should be maintained within the given specifications. Please refer to “AC Characteristics” for more detail on timing.

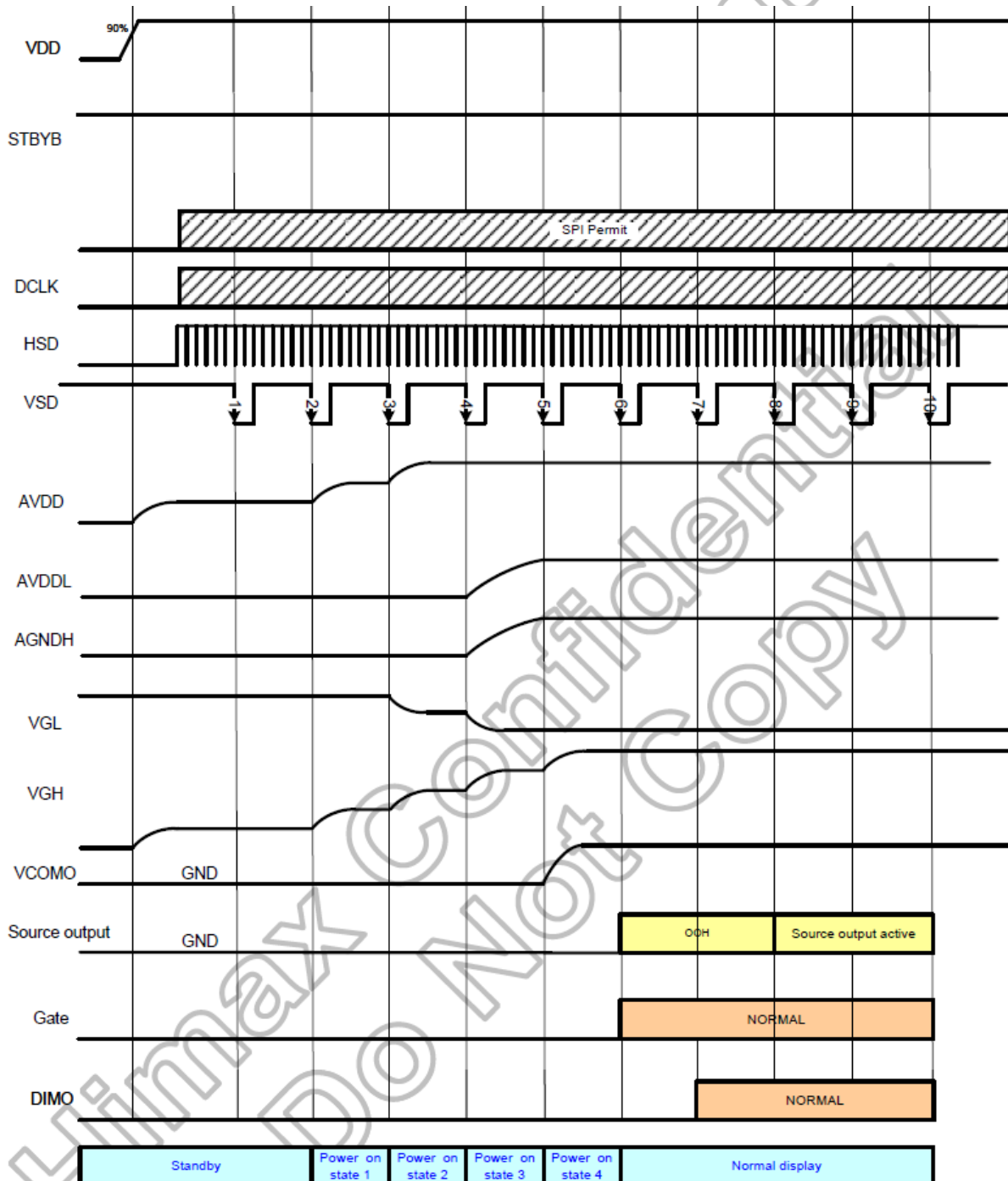

9. Reliability and Inspection Standard

No.	Test Item	Test Conditions	Remark	
1	High Temperature	Storage	80°C, 120Hr	Note
		Operation	70°C, 120Hr	Note
2	Low Temperature	Storage	-30°C, 120Hr	Note
		Operation	-20°C, 120Hr	
3	High Temperature and High Humidity	40°C, 90%RH, 120Hr	Note	
4	Thermal Cycling Test(No operation)	-20C for 30min, 70c for 30 min. 100 cycles. Then test at room temperature after 1 hour	Note	
5	Vibration Test(No operation)	Frequency :10~55 HZ; Stroke :1.5 mm;Sweep:10HZ~55HZ~10HZ; 2hours for each direction of X, Y, Z(6 hours for total)		
6	Package Drop Test	Height:60 cm,1 corner, 3 edges, 6 surfaces		
7	Electro Static Discharge	±2KV,Human Body Mode, 100pF/1500Ω		

Note:

- 1) Sample quantity for each test item is 5~10pcs.
- 2) Note 4: Before cosmetic and function test, the product must have enough recovery time, at least 2 hours at room temperature.

10. PRECAUTIONS FOR USING LCD MODULES

Handling Precautions

- (1) The display panel is made of glass and polarizer. As glass is fragile, it tends to become or chipped during handling especially on the edges. Please avoid dropping or jarring. Do not subject it to a mechanical shock by dropping it or impact.
- (2) If the display panel is damaged and the liquid crystal substance leaks out, be sure not to get any in your mouth. If the substance contacts your skin or clothes, wash it off using soap and water.
- (3) Do not apply excessive force to the display surface or the adjoining areas since this may cause the color tone to vary. Do not touch the display with bare hands. This will stain the display area and degraded insulation between terminals (some cosmetics are determined to the polarizer).
- (4) The polarizer covering the display surface of the LCD module is soft and easily scratched. Handle this polarizer carefully. Do not touch, push or rub the exposed polarizers with anything harder than an HB pencil lead (glass, tweezers, etc.). Do not put or attach anything on the display area to avoid leaving marks on. Condensation on the surface and contact with terminals due to cold will damage, stain or dirty the polarizer. After products are tested at low temperature they must be warmed up in a container before coming in contact with room temperature air.
- (5) If the display surface becomes contaminated, breathe on the surface and gently wipe it with a soft dry cloth. If it is heavily contaminated, moisten cloth with one of the following solvents
 - Isopropyl alcohol
 - Ethyl alcoholDo not scrub hard to avoid damaging the display surface.
- (6) Solvents other than those above-mentioned may damage the polarizer. Especially, do not use the following.
 - Water
 - Ketone
 - Aromatic solventsWipe off saliva or water drops immediately, contact with water over a long period of time may cause deformation or color fading. Avoid contacting oil and fats.
- (7) Exercise care to minimize corrosion of the electrode. Corrosion of the electrodes is accelerated by water droplets, moisture condensation or a current flow in a high-humidity environment.
- (8) Install the LCD Module by using the mounting holes. When mounting the LCD module make sure it is free of twisting, warping and distortion. In particular, do not forcibly pull or bend the I/O cable or the backlight cable.
- (9) Do not attempt to disassemble or process the LCD module.
- (10) NC terminal should be open. Do not connect anything.
- (11) If the logic circuit power is off, do not apply the input signals.
- (12) Since LCM has been assembled and adjusted with a high degree of precision, avoid applying excessive shocks to the module or making any alterations or modifications to it.
 - Do not alter, modify or change the shape of the tab on the metal frame.
 - Do not make extra holes on the printed circuit board, modify its shape or change the positions of components to be attached.
 - Do not damage or modify the pattern writing on the printed circuit board.
 - Absolutely do not modify the zebra rubber strip (conductive rubber) or heat seal

connector.

- Except for soldering the interface, do not make any alterations or modifications with a soldering iron.
- Do not drop, bend or twist LCM.

Storage Precautions

When storing the LCD modules, the following precaution is necessary.

- (1) Store them in a sealed polyethylene bag. If properly sealed, there is no need for the dessicant.
- (2) Store them in a dark place. Do not expose to sunlight or fluorescent light, keep the temperature between 0°C and 35°C.
- (3) The polarizer surface should not come in contact with any other objects. (We advise you to store them in the container in which they were shipped).

Others

Liquid crystals solidify under low temperature (below the storage temperature range) leading to defective orientation or the generation of air bubbles (black or white). Air bubbles may also be generated if the module is subject to a low temperature.

If the LCD modules have been operating for a long time showing the same display patterns, the display patterns may remain on the screen as ghost images and a slight contrast irregularity may also appear. A normal operating status can be regained by suspending use for some time. It should be noted that this phenomenon does not adversely affect performance reliability.

To minimize the performance degradation of the LCD modules resulting from destruction caused by static electricity etc., exercise care to avoid holding the following sections when handling the modules.

- Exposed area of the printed circuit board.
- Terminal electrode sections.